



Subject to technical alterations • 06/11 • © Wheelabrator Group

HT Overhead monorail blast cleaning machine



DISA Industrie AG
Kasernenstrasse 1
CH-8184 Bachenbülach

T: +41 44 815 4000
F: +41 44 815 4001
E: zurich@wheelabratorgroup.com
www.wheelabratorgroup.com
www.disagroup.com

Noricor Group is the parent company of DISA and Wheelabrator.

wheelabrator
shaping industry

wheelabrator
shaping industry

HT Overhead monorail blast cleaning machines



Hanger-type solution with monorail for shot peening of stabilizers for passenger cars



Hangers are adapted to the production programme



Blast chamber of a HT 3-13 / 21

Accomplishing blast cleaning tasks and solving transport problems at the same time

Wheelabrator Overhead monorail blast cleaning systems include a number of heavy duty variations for different production areas, e.g. foundries and forges. Hanger-type blast cleaning machines offer ideal conditions for effective and economical blast cleaning. The use of hangers allows for the reliable and economical blast cleaning of components, from small to very large workpieces.

Unlimited applications

- Desanding, decoring and final blast cleaning of iron, steel and light metal castings, including parts susceptible to breakage and impact damage
- Descaling of forgings, hardened or heat treated steel parts
- Derusting, roughening, finishing,
- Shot peening

In addition to their versatility, Wheelabrator hanger-type blast cleaning systems offer a great number of further advantages:

- Heavy duty, compact and rugged design for long service life
- High blasting capacity and efficiency
- Economical abrasive consumption, reliable cleaning and dust collection
- A wide range of machine types for different production rates and workpieces of different sizes
- Easy integration into existing production lines with a variety of options for step-by-step extension and automation (modular design)
- Long life due to use of highly wear-resistant material

- High operational safety, low maintenance and maintenance-friendly design (easy access to maintenance areas, external bearings, easily replaceable wear parts)
- High sand separation capacity with combined magnetic and air-wash separation

Design versions



Blastroom with travelling crane for large and heavy parts.

Proven solutions

The basic series comprises machine modules of different sizes equipped with 2, 3, 4 and more blast wheels. Depending on the dimensions of the parts to be cleaned and the output required, it is possible to connect several machine modules in series. The concept covers machines for reversible or for through-feed operation. For processing large parts, inlet and outlet vestibules can be provided.

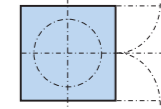

Basic design with reversing conveyor system

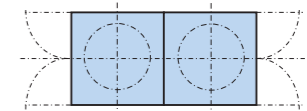

Extension for increased output

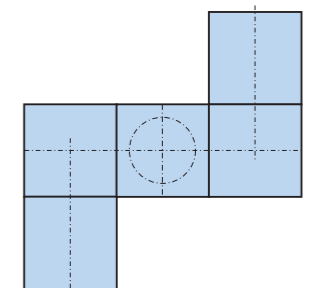
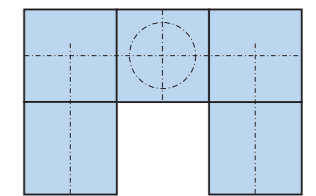
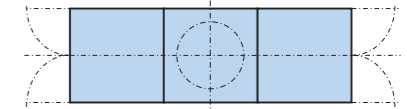

Extensions for high output and special blast cleaning programmes. Inlet and outlet vestibules with rubber curtains. Different layout possibilities

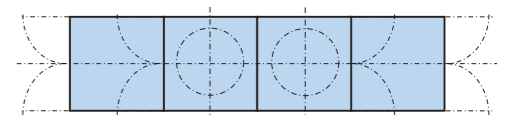

Extension with additional cabins for large workpieces

Machine components



HT 2-13/15 at manufacturer's workplace

Important machine components:

- Sturdy welded housing structure reinforced with profiles
- Heavy-duty blast wheels
- Vibrating conveyors or screw feeders, in line with the relevant application
- Abrasive circuit
- Abrasive cleaning
- Monorail

Surfaces directly exposed to the blasting stream and subject to increased wear are protected by replaceable manganese steel liners or, if required, by hardened tool steel liners. The unique blast wheel arrangement ensures that all faces of components, even with undercut walls and surfaces, can be cleaned in one passage.

The workpieces are carried on hangers which, inside the blast cleaning zone, are subjected to either a rotary and oscillating motion or only a rotary motion in various blasting positions ensuring that complete cleaning of the workpiece surfaces is attained.



Hanger-type shotblast machine for reconditioning gas bottles



Hanger-type shotblast machine for through-feed operation

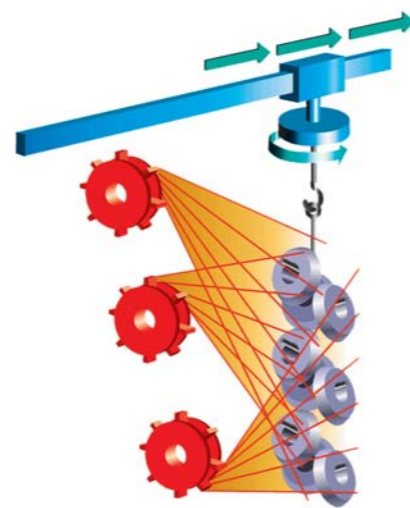

Overhead monorail system



Customised monorail system with switch points



Hanger-type machine with monorail loop for desanding automotive components.



12 blast wheels, 37 kW each.

Overhead monorail systems: More than simply a blasting solution

Overhead monorail systems as transport equipment offer a variety of possibilities for optimum material flow and contribute to a considerable reduction of finishing costs. Overhead monorail systems accomplish blast cleaning tasks while at the same time solving handling problems to benefit the overall production process. Rails, switch points and crossings permit the material flow to any further operation. Routing changes or extensions can be implemented without great expenditure.

The transport hanger is loaded outside the machine by hand, forklift, crane, lifting gear or robot and then moves into the shot blast cabin where all surfaces of the workpieces are treated in one passage.

Reversible or through-feed operation

In the blasting zone the hanger is rotated and oscillated using a drive unit. Reversing operation (clockwise and counter-clockwise rotation) is available as an additional mode. This mode of operation allows shot blasting at different angles to the workpiece to avoid blast shadows.

Loop principle

For parts susceptible to impact damage, several passes can be made through the shot blast machine by using loops, exposing a different workpiece surface on each pass.

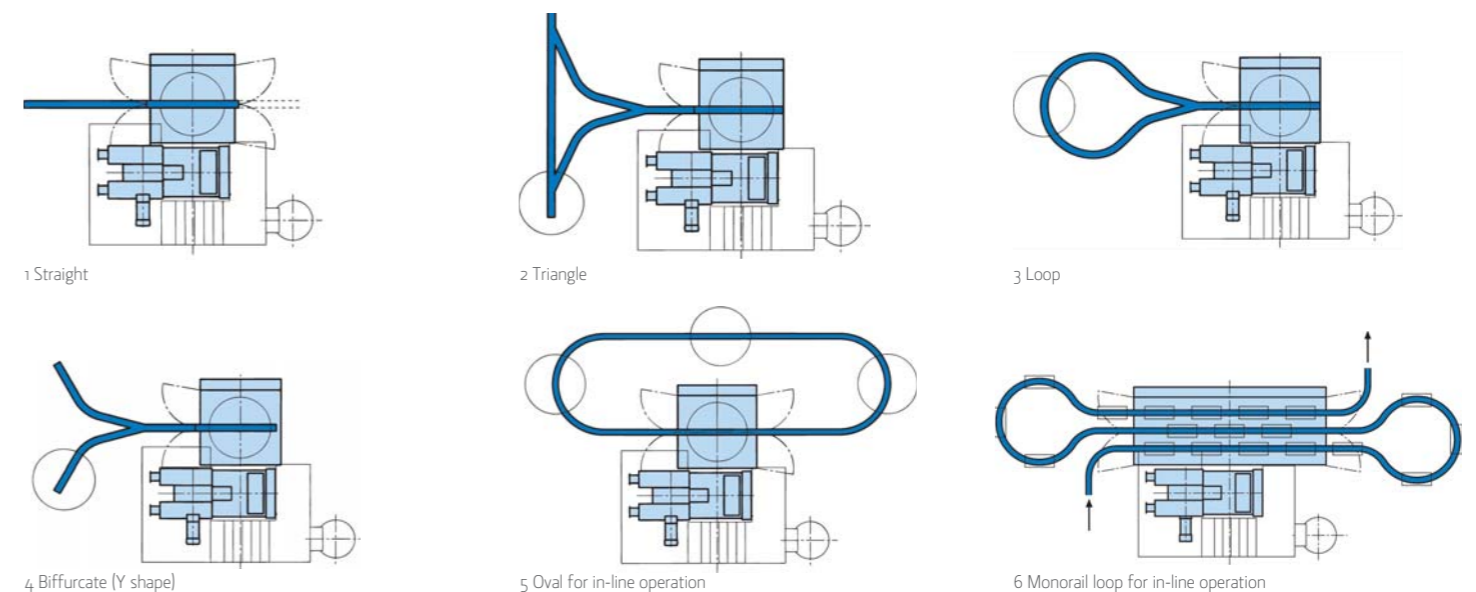

Hanger systems



Blast house for large castings



Robotic loading of hangers

Crane and transfer systems



Blastroom with wheels on a tower



Standard Hanger Systems

The shape and design of the hangers depends on the parts to be cleaned and the task to be performed. The range of possible solutions cover:

Manually actuated hangers

For small series and unit weights of up to 2000 kg, manually actuated hangers can be used. Electric driven systems with lifting gear for loads up to 20 000 kg (30 000 kg, special design) can be designed upon request.

Hangers driven by chain conveyors

Chain conveyors offer a variety of extension possibilities and are suitable for companies processing small to medium-size parts.

- Power and Free systems; with individual rail layouts for loads of up to 10 000 kg per hanger
- Circular conveyor systems with connector chains for intermittent or through-feed operation, for loads up to 10 000 kg

Motor-driven automatic hangers

Motor-driven automatic hangers are suitable for small, medium and large-size parts.

- Electric overhead monorails with automatic drive mechanisms for loads up to 10 000 kg

Pre-programmable drive mechanisms roll on a carrying rail with power supply and have individual drive units. Loading and unloading areas can be perfectly adapted to local conditions. To control the direction, the hangers travel in a system of switch points, sluices, lifting and lowering elements are integrated into the overall monorail system.

- Monorail crane systems with lifting gear, for loads up to 50 000 kg
- Crane systems with lifting gear, for practically unlimited loads.

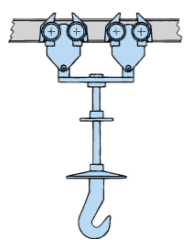

Single hanger, manual movement

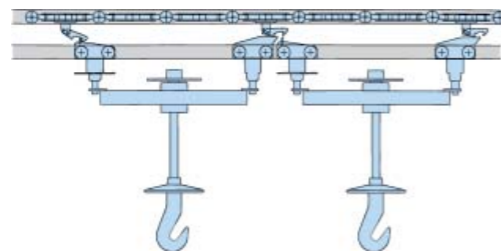

Power and free conveyor

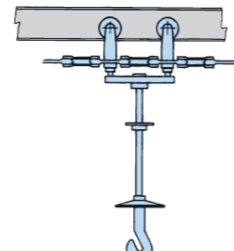

Chain attachment

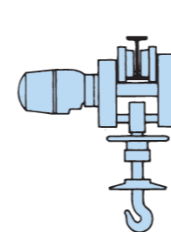

Electric drive mechanism

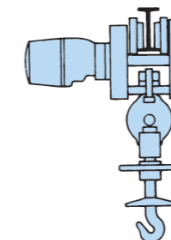

Electric lift and drive mechanism

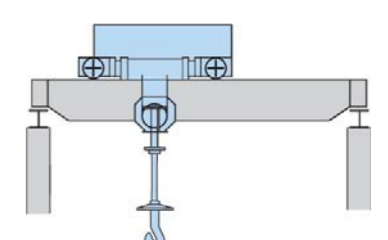

Crane drive mechanism with lifting gear

Blast wheel



The blast wheels: Highly efficient and precise

Wheelabrator blast wheels are known for high capacity and maximum energy efficiency. They are available in different sizes to meet individual requirements. Due to the reversibility of the blast wheel rotation, the range of applications can be considerably extended.

The throwing power of the wheels and shot impact are fine-tuned to suit specific applications and to ensure optimal energy efficiency. The amount of abrasive can be adjusted from the operator's panel. The abrasive is mechanically pre-accelerated and delivered to the blast wheel in a continuous stream, fully utilising the drive power of the motors to achieve the best blast cleaning effect.

The careful arrangement of the blast wheels plus the ability to adjust the throwing angle of the abrasive, assure that workpieces are always blast cleaned in the hot spot. Machine components within the throwing range of the blast wheels are made of highly wear-resistant material to avoid excessive wear.

- 1 Wheel body
- 2 Control cage
- 3 Impeller
- 4 Blade



Efficient cleaning



Efficient cleaning of abrasive for perfectly clean castings: Reconditioning of abrasive and dust collection

Clean workpieces are reliant on clean abrasive: Abrasive contaminated by moulding sand, core sand or scale will considerably reduce the cleaning capacity of any shot blast machine. It will, moreover, increase wear and cause deposit built-up on the workpieces. Sand, scale, heavy dust, fines and undersized abrasive have to be effectively removed. Taking the type and possible degree of impurities into account, Wheelabrator uses proven separation systems for this purpose:

- Magnetic separators with final pneumatic cleaning for heavily contaminated abrasive (generated in combined shot blasting, decorating, and desanding plants)
- Pneumatic separators for other applications

The dust produced is completely separated using appropriate filters. Continuous dust collection assures an efficient and environmentally responsible operation and perfect functioning of the abrasive separators.

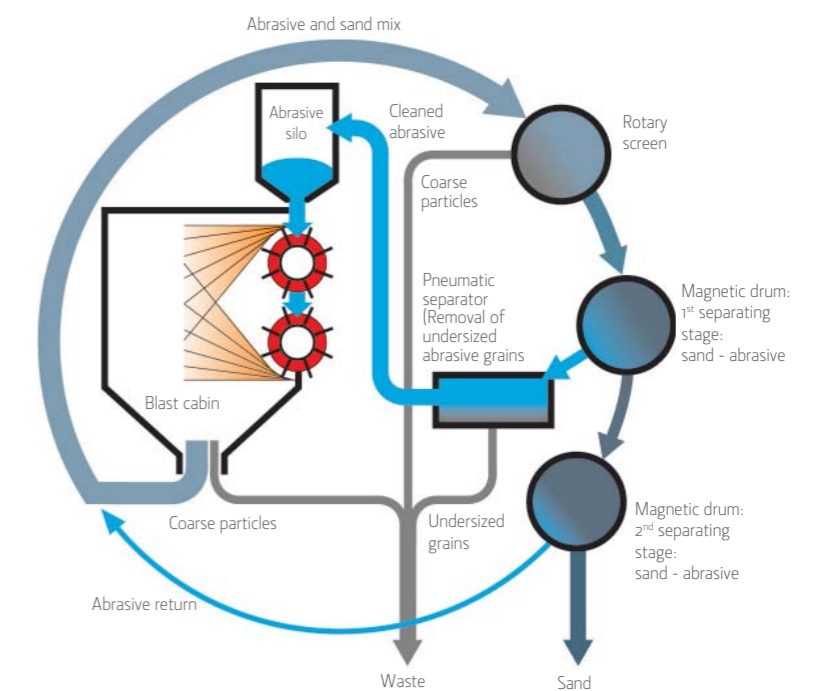

Features and benefits



Advanced work-place ecology, easy maintenance, high operational safety

In view of today's heavy workloads, long maintenance intervals and minimal maintenance expenses are vital. Appropriate measures ensure good wear properties and complete ease of maintenance. Simple but effective sealing elements prevent leakage of shot. An efficient dust collector and a closed-loop abrasive transport system within the machine ensure environmentally responsible operation. The unique machine structure and easily accessible service

platforms facilitate visual inspections and routine maintenance work. Safety elements make sure that access to the shot blast chamber is only possible when the machine is switched off and the blast wheels are no longer rotating.

Original wear and spare parts along with Wheelabrator Plus service are the best prerequisites to keep the blast cleaning system in perfect operating condition.

Technical Data

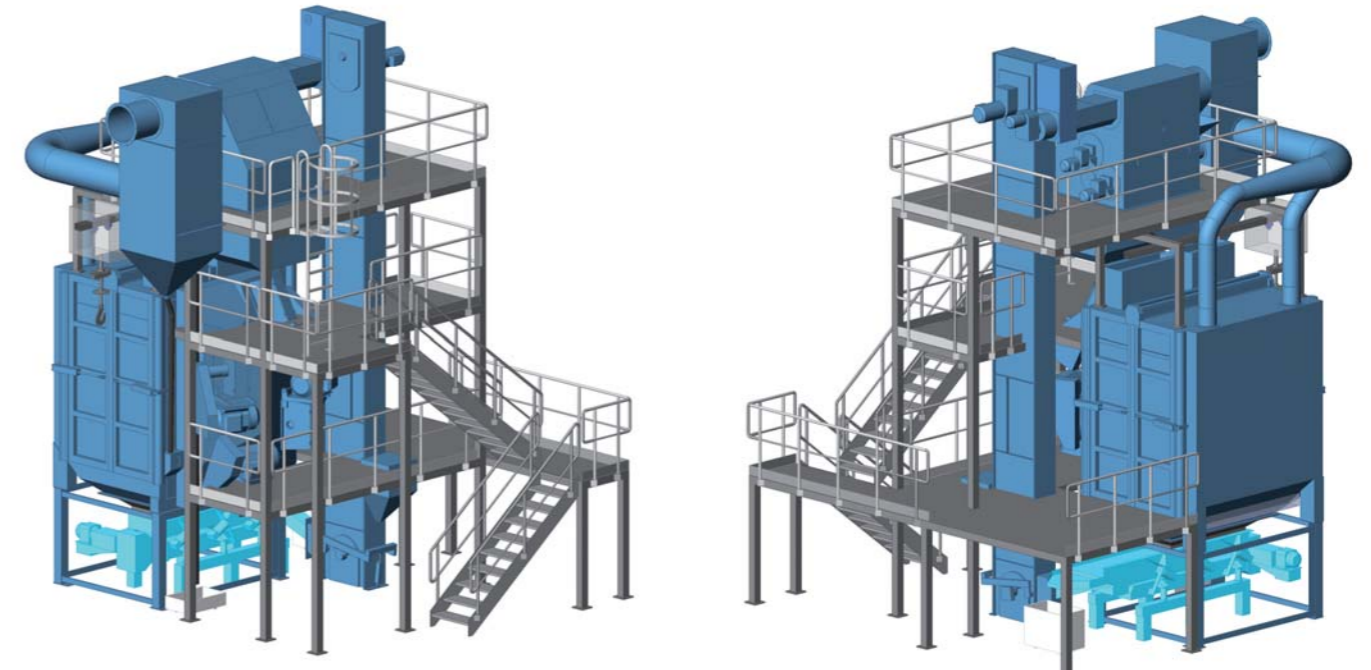

Standard machine modules

- HTR Hanger type shot blast system, reversible operation
- HTT Hanger type shot blast system, through-feed operation
- HTC Hanger type shot blast system, combination of through-feed operation and rotation movement

Envelope circle $\varnothing D$ (mm)	850 - 1800
Hanger height C (mm)	1100 - 2200
Number of blast wheels	2 / 3 / 4 extension in modular system
Power per wheel (kW)	5.5 - 37

Further machine types and measurement specification sheets are available upon request.